



OPERATION MANUAL

Applicable product model:

GL-F-10M

Contents

1. Use Instruction	1
2. Safety tips	2
3. Precautions for use	4
4. Product installation	4
4.1 Installation environment	4
4.2 Installation Site	4
4.3 Pre-installation	5
4.4 First time use	5
4.5 Power off operation	6
5. Components and Overview	6
6. Control panel description and function setting	8
7. Defrost, Unused and Maintenance	9
7.1 Defrost, Unused and Maintenance	9
7.2 Disposal of the Equipment	9
8. After-sales service	9
9. Specification	10
10. Performance	11
10.1 Main Technical Parameter	11
10.2 Packing List	11
10.3 Electrical Diagram	11

1. Use Instructions

Thank you for choosing Glacier Products. For your safe, convenient use and reasonable maintenance of this product, you are requested to read the instructions carefully before use and keep them properly for reference.

Device operators can copy some chapters of this manual, but only use it internally, for example, to instruct users such as:

How to deal with emergencies? These chapters are clearly identified in the catalogue of the manual. Glacier is not obligated and responsible for any instrument damage caused by the user's failure to use the equipment in accordance with the manufacturer's method as stated in the manual.

Due to the rapid upgrade of Glacier's products, the functions described in this manual may be inconsistent with those of the products you purchased. Please refer to the physical functions.













- Please read the notes and safety precautions carefully.
- In order to make the equipment work properly, please install it according to the correct installation procedures. Medical freezers can only be operated by trained and authorized person.
- Maintenance of the equipment can only be performed by Glacier or Aegis Authorized Agents.
If the operator encounters situations not mentioned in this manual, please contact the authorized agent of
- Glacier or Aegis and ask for the correct treatment.
If the equipment is not used according to the procedures prescribed, it may damage the equipment.
- It is necessary to use the accessories provided by Glacier, such as compressors, controllers, sensors, etc. If
- users want to use other accessories, they may have adverse consequences, such as affecting performance, protection and service life.
Medical freezers must be inspected and maintained within a specified time interval.
- Due to the upgrade of the products and the different models, the actual products may be different from the
- sketch, please take the physical object as the criterion. The sketch is only an example of identifying the function parts.









Friendly Reminder :













- Always use protective equipment correctly (including clothing, gloves, goggles, etc.)
- Always adopt good hygiene habits.
- Everyone has an obligation to be responsible for his or her own safety









2. Safety tips

- When using this product for the first time, please pay attention to the following warning signs and read the safety precautions carefully so that you can use the equipment safely and correctly

 Warning: Failure to comply with precautions may result in serious personal injury or death	 Failure to comply with precautions may result in injury to personnel, equipment failure and related property losses.
 Grounding mark	 Flammable and explosive refrigerating medium, away from the source of fire!
 Do not tilt	 Avoid direct sunlight
 No clips!	 Items in the box must be placed in the direction of arrows.
 Handle with care	 Avoid rain
 No stacking	 Prevent electric shock

 Warning: Failure to comply with precautions may result in serious personal injury or death.
 Do not touch the equipment with wet hands to avoid the danger of electric shock.
 This equipment can only be installed by professional technicians or after-sales maintenance personnel, otherwise it may lead to electric shock or fire.
 Be sure to install the medical freezer on a solid, flat floor and pay attention to it in case turns over. If the ground is not solid enough or the installation site is inappropriate, it may cause the equipment to overturn and cause equipment damage or personnel injury.
 Please handle the power cord carefully to avoid short circuit. Turn off the power supply before pulling out the power plug. Hold the power plug carefully and pull out. Do not pull the lead of the power plug. Otherwise, it may cause electric shock or fire due to short circuit. Do not tie the power cord, do not press under furniture or heavy objects, do not close to heat sources such as compressors.
 Please insert the power plug firmly to avoid leakage.
 It is necessary to use a separate special socket and grounding reliably. The length of the power line should not be lengthened at will. If it really needs to be lengthened, it is necessary to use more than 2.5mm ² copper conductor. The cross-sectional area of the copper conductor in the wall connected with the power socket must also be guaranteed to be more than 4mm ² . In case of heat or fire.
 Do not use power sources other than those specified in the design of equipment to avoid overheating and short-circuit faults. If 110V rated voltage products are connected to 220V power supply, overheating and burning equipment may occur. The machine uses 220V/50HZ AC power supply. If the voltage is too low or too high, it needs to be equipped with appropriate automatic regulator to cooperate with the use.
 Please keep the blood refrigerator stable and avoid shaking.

	Do not place this medical freezer in dangerous areas, do not operate equipment near inflammable articles, to prevent explosion or fire accidents.
	Do not place the blood refrigerator in the area where the sun or rainwater drips, so as to prevent dangerous accidents such as short circuit or overheating of the equipment.
	Do not tilt or lie sideways, do not impact the fuselage of the equipment; the equipment is equipped with refrigeration system, which is easily damaged by rolling or impact.
	Please put the blood refrigerator in a dry and dustless environment to avoid the danger of overheating and short circuit.
	If unexpected sounds, smells, smoke and so on occur when the power supply is switched on, please pull out the power supply in time and contact the manufacturer or supplier.
	Please place the blood refrigerator in a dry and ventilated environment to ensure that the ventilation outlet and the surface of the instrument are not blocked or blocked by walls or other objects. Do not use it in a poorly ventilated environment to prevent damage caused by overheat
	It is forbidden to dismantle or alter the equipment without authorization in order to avoid potential safety hazards. Meiling Biomedical will not be responsible for any quality accidents in this case.
	It is strictly forbidden to put inflammable, explosive dangerous goods and strong corrosive acid, alkali and other articles which are not suitable for refrigeration in this medical freezer.
	When storing toxic, harmful or radioactive materials, please use medical freezers in safe areas. If improperly used, it may cause harm to human health or the environment.
	Metal objects such as nails or wires shall not be inserted into any orifice and clearance or any outlet of the blood refrigerator, otherwise electric shock or injury may be caused by accidental contact between the above-mentioned objects and the moving parts.
	In order to ensure the normal operation of the machine and ventilation and heat dissipation, the back of the box body and the left and right sides are at least 30 cm away from the wall. Please do not block the air inlet and outlet.
	This device must be connected to the ground wire.

	Note: Failure to comply with the precautions may result in injury or equipment failure and related property losses.
	When the medical freezer is not in use for a long time, please unplug the power plug and pack it for properly.
	When restarting the medical freezer after power off, please check the equipment parameters first, otherwise the storage items may be damaged due to the change of parameters.
	The medical freezer is a storage device for articles, and can not be used as a production equipment!
	Hold the handle and close the door so that it doesn't clip to your finger.
	Keep the keys properly to avoid accidents when children open the door and play after they get them.
	When moving the equipment, please be careful not to let the equipment turn over, in case the equipment is damaged or personnel are injured.
	Pay attention to check the filter in time and clean it regularly. In order to avoid dust blockage and poor ventilation leading to temperature rise or malfunction of blood refrigerator.
	When carrying, it should be lifted from the bottom. The inclined surface should not be greater than 45 degrees. It should be handled lightly.

3. Precautions for use

- ◆ Before putting the items into the medical freezer, please confirm whether the temperature in the chamber has reached the set temperature, and then put the items in batches. Should put not more than 1/3 of the items each time in order to prevent excessive temperature rise.
- ◆ Clean the unit with diluted neutral detergent. Brushes, acids, gasoline, soap powder, polishes or hot water should not be used to clean medical freezers, as the above materials may damage the painted surface and plastic rubber parts. Be careful not to use volatile solvents such as gasoline to wipe plastic rubber parts.
- ◆ When the medical freezer is not used for a long time, the power supply should be cut off
- ◆ There should be no obstruction around the medical freezer to keep ventilation smoothly. When the medical freezer does not need to be restarted for a long time, there may be a low battery situation. It should be ensured that the battery switch is in the "ON". At this time, the battery can be charged. The medical freezer can run continuously for about a week and the battery can be fully charged.

4. Product installation

4.1 Installation environment

- Ambient temperature: $16^{\circ}\text{C} \sim 32^{\circ}\text{C}$, and the optimum temperature is $18^{\circ}\text{C} \sim 25^{\circ}\text{C}$ and air conditioning system should be used when necessary.
- Relative humidity: $\leq 80\% \text{RH}$
- There is no strong vibration and corrosive gas around.
- Avoid large amounts of dust
- Avoid machine swing or vibration.
- Unit working altitude: below 2000m
- The input voltage $220\text{V} \pm 10\%$.
- Without the influence of direct sunlight and other cold and heat sources and the existence of electromagnetic interference, electromagnetic interference will affect the normal operation of the control system, and will directly damage the system in serious cases.

4.2 Installation Site

In order to make the blood refrigerator work normally and obtain the best performance level, the installation site of the blood refrigerator should meet the following requirements:

- Can not be installed in narrow and closed space, the door body of the room should not be less than the equipment, at least ensure the normal entry and exit of the equipment, in order to avoid the maintenance difficulties caused by the failure of the equipment, unable to repair the equipment in time, causing damage to storage items;
- The installation ground must be firm and smooth.
- Good ventilation to avoid direct sunlight;
- Do not share a socket with other devices. The plug is firmly connected to the socket;
- If it is really necessary to lengthen the power cord, it is necessary to use more than 2.5mm^2 copper-core conductors. The cross-sectional area of copper-core conductors in the wall connected with the power socket must also be used. It is guaranteed to be over 4mm^2 . After installation, the power plug must be accessible to the user, so that the power cord can be pulled out in case of emergency.
- Check the working voltage before use. In areas where the voltage is unstable, the voltage stabilizer suitable for equipment load should be considered. Guarantee Input voltage is stable at $220\text{V} \pm 10\%$, Voltage regulator power greater than 4KW;
- Reliable grounding of medical freezers;
- If the power line socket is equipped with grounding wire, check whether the grounding is good before use.
- If the socket is not equipped with grounding wire, it must be installed by professional engineers and technicians.

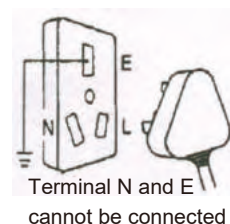



Warning

- Do not ground the blood refrigerator through gas pipe, water pipe, telephone line or lightning rod, which may easily cause electric shock
- After installation, the power plug must be accessible easily to convenient to unplug the power cord in case of emergency
- Do not cover the vents of the blood refrigerator

4.3 Pre-installation

- Remove all packaging components (including protective foam inside the box)
Note: do not put plastic bags within children's reach to prevent suffocation accidents
- Counting accessories: please check the accessories and materials according to the packing list
- Cleaning: the product should be cleaned before use.
- Standing: after leveling and cleaning the cabinet, do not switch on the power supply firstly. It shall be placed for more than 2 hours before switching on the power to ensure the normal running

4.4 First time use

1. When use medical freezer for first time, please follow these steps:

1. In the case of empty load, connect the power cord to the appropriate specifications of the special socket.
2. After turning on the power supply, turn on the power switch at the right bottom of the refrigerator.
3. This medical freezer has been preset to temperature (3-5°C), do not need to set temperature.
4. Press the mute button to eliminate the alarm buzzing.
5. Check the chamber temperature whether reach the required temperature or not, observed the medical freezer whether running normally for more than 24 hours. After refrigerator temperature is normal and stable, you can put a small amount of items placed in the medical freezer. Please store the goods in batches, each time shall less than 1/3 of the refrigerator capacity. Ensuring that the blood refrigerator is running for another more than 12 hours before putting in the other 1/3 items of the refrigerator capacity).
6. Try not to open the door in the process of cooling, otherwise it will cause temperature rise



Attention

- This product should be responsible by a special person, check the running state and record every day (every 2 ~ 4 hours record and check). In case of failure or shutdown, the temperature in the blood refrigerator will rise. If it cannot be repaired within a short period of time, please take out the stored items and transfer them to a place that meets their temperature requirements to avoid damage.
- Before putting the samples into the blood refrigerator, the temperature required by the samples should be confirmed in advance in accordance with the temperature range of the blood refrigerator, so as to avoid damage to the stored goods because the temperature of the blood refrigerator does not reach the temperature required by the samples.
- Due to the inertia of refrigeration, there was some difference between the temperature actually displayed and the set temperature, this is a normal phenomenon.
- All the medical freezers are designed to store, it is forbidden to put too much relative hot items in one-time, otherwise it will lead to compressor does not stop but keep refrigerating which is easy to get burnt. Items must be put in batches, drop the temperature to the required temperature stage by stage.
- It is not allowed to use unauthorized electric appliances inside of the refrigerator
- Please make sure that there is a certain air circulation space around the chamber when putting in the items, especially do not block the temperature sensor located inside of the refrigerator (for the temperature collection), otherwise it will affect the stability and accurate display and control of the chamber temperature

4.5 Power off operation

The medical freezer has the memory function regarding the set value, when power off and then connect to the power supply again, the refrigerator will continue to operate before the power off. Once the power supply of the blood refrigerator is interrupted in use, it needs to wait for 5 minutes before it can be reconnected to avoid damage to the compressor

※Our company guarantees the equipment under certain conditions but we are not responsible for any loss or damage of the goods

5. Components and Overview

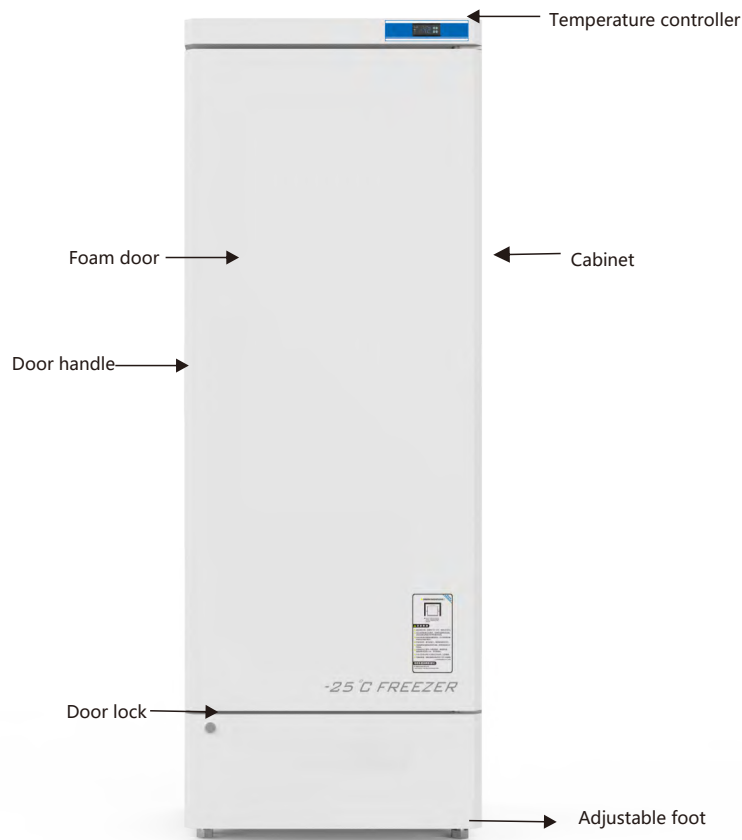

GL-F-10M

Due to the improvement of the product and the different models, the actual product may be different from the simplified one. Please refer to the actual product!

Structure and composition: The product consists of a cabinet, a door, a refrigeration system, and a control system.

Scope of application: This product is suitable for storing items in hospitals, pharmacies, epidemic prevention stations, research institutions, biopharmaceuticals, etc.

The storage temperature inside the cabinet can be adjusted through the temperature button on the control panel, which is convenient to use and reliable in performance.

6. Control panel description and function setting



1. Temperature controller interface

1.1 Indicator light status

Indicator light	Symbol	Status	Meaning
Set indicator	set	Light	Parameter settings
		Dark	Measurement and control status
Cooling indicator	❄️	Light	Refrigeration work
		Dark	Refrigeration stop
		Blink	Refrigeration delay
Measuring unit indicator	°C	Light	Display unit
The indicator of checking the temperature setting	👁️	Light	Checking the temperature setting

2. Function setting

2.1 Check temperature settings

In the normal running state, press and release the Set button to display the temperature setting value, and the 👁️ indicator light is on; Press the Set button or wait for 15 seconds without operation to resume normal temperature display.

2.2 Modify the temperature set value

- 1) Pressing the Set button for 2 seconds;
- 2) The current temperature set value will be displayed and the Set indicator will light;
- 3) Modify the set value by pressing the ▲ or ▼ button in 15 seconds;
- 4) Press the Set button or wait for 15 seconds without operation to store the new set value.

3. Lock/unlock the keyboard

Press and hold the ▲+▼ button combination for more than 3 seconds. The panel displays the 'oF' character and the keyboard is locked. When the keyboard is locked, parameter adjustment cannot be performed by button operation. Press and hold the ▲+▼ button combination for more than 3 seconds. The panel displays the 'on' character and the keyboard is unlocked.

4. Alarm code display

Alarm code	Fault description
P1	sensor failure
HA	high temperature alarm
LA	low temperature alarm
dA	door open alarm

After the alarm sound is artificially eliminated in the fault state, the fault delay alarm will not start if a new fault occurs, that is, the digital tube will flash to display the fault code, and the buzzer will no longer alarm; The fault delay alarm will not be effective until all faults have been eliminated, and the buzzer can re-alarm.

- Do not immediately put any items in the medical freezer when just connect to the power. Let the refrigerator run for a period (about 24 hours), and then put the items in the refrigerator.
- When put in items to the refrigerator, if the item is too moist or too dry, it will affect the change of humidity in the box. The item is best sealed and stored. Similarly, the humidity of the working environment of the medical freezer will also affect the humidity change in the box, especially the excessive opening of the door or the door is not closed.
- Each time for storing items, they cannot exceed 1/3 of the cabinet capacity, after reach the actual temperature and run normally for 24 hours, then put another 1/3 of the cabinet capacity items.
- Please be careful not to block the air outlet and the air inlet when put in the items.
- Do not place the item directly on the bottom of the medical freezer. It should be placed on the bottom rack; otherwise it will affect the cooling effect of the medical freezer.
- Do not open the door during the cooling process; otherwise it will cause the temperature to rise.
- Due to the cooling inertia, the display temperature and the set temperature may be different when the product reaches the set value and shutdown. This is a normal phenomenon.



Warning: Please keep the medical freezer out of reach of children.

7. Defrost, Unused and Maintenance



Warning:

- In order to prevent personnel electric shock or injury, please cut off the power supply of the storage box before any repair and maintenance to ensure that no drugs or suspended particles around the device will be inhaled during the maintenance, otherwise it will endanger your health

7.1 Defrost, Unused and Maintenance

After working for a period of time, the inner surface of the product will be frosted, which will affect the cooling effect and increase the power consumption. It is recommended that the frost layer should be defrosted when it is too thick.

Turn off the power, open the door, and transfer the items to a cool place;

Use a defrosting shovel to gently remove the surface area cream (also let the temperature inside the cabinet rise naturally, melting the frost);

In order to speed up the defrosting process, a flat-bottomed container filled with hot water of less than 50 °C can be placed in a storage cabinet. Then use a dry cloth to clean the remaining ice water from other places. Reload the item into the storage cabinet;

Turn on the power and turn it on.

 **Note:** Do not use sharp metal tools during defrosting to avoid damage to the storage cabinet.

If the product needs to be stopped for a long time, the power should be cut off, cleaned as follows, and sealed after drying.

Before using it again, use a dry cloth to dry the water around the door of the cabinet.

Do not place heavy objects on top of the freezer to avoid deformation of the cabinet.

 **Note:** DO NOT sprinkle water on the faces of cabinets, which may decrease insulating property of electric parts and rust metal parts. DO NOT use hot water, corrosive cleanser and organic solvent! Condition: Cannot shake heavily, strike, and prevent drench. Environment Temperature: $-40^{\circ}\text{C} \sim +55^{\circ}\text{C}$, Relative humidity: 10%~90%.

7.2 Disposal of the Equipment

 **Warning:** If the equipment is stored in an unsupervised area for a long time and unused, please ensure that the child will not get close to the unit and the door cannot be completely closed. The disposal of equipment should be carried out by corresponding personnel to prevent accidents such as asphyxiation.

8. After-sales service

Any product has the possibility of failure, please observe the operation of the refrigerator in time in the process of using. If there is any abnormality, please check and deal with it according to the table below. If the situation cannot be changed, please contact our service center in time. We will serve you wholeheartedly so as not to cause you any loss. Term of use: 10 years.

Problem	Possible Cause
The blood refrigerator does not operate	<ul style="list-style-type: none">➤ Is there electricity in the power plug?➤ Is the power switch ON ON the side of the blood refrigerator turned ON?➤ Is the power plug plugged in or loose?➤ Is the power fuse disconnected?➤ Is the power supply voltage too low or too high?
Compressor does not work	<ul style="list-style-type: none">➤ Is the ambient temperature too high for the compressor to protect itself?
The temperature does not reach the set value	<ul style="list-style-type: none">➤ Frost in inner wall is too thick➤ Is the door not tight or open too many times?➤ Are you putting too many things in at once?➤ Is the ambient temperature too high?➤ Solution: Please leave the distance between the unit and the wall around the best in more than 30 cm, and the outlet and outlet should not be blocked, hot summer should pay attention to room ventilation or open air conditioning. (ambient temperature: 16 ~ 32 °C)
Too noisy	<ul style="list-style-type: none">➤ Refrigerator is not leveled well.➤ Refrigerator leans upon the wall.

Below are normal operations :

(1) compressor start, stop, switch parts creates a slight crash sound.

(2) Rainy wet season, the door surface may condensation, dry cloth can be wiped away.

(3) power failure for a long time, and did not turn off the general power switch, resulting in battery loss, re-energized after the display is not normal, when the need to turn off the general power switch, 1 minute after the re-open can.

Before notifying the maintenance engineer, the user shall clean and disinfect the machine. Storage and transportation conditions: no violent vibration or collision shall be allowed during transportation or use to prevent rain. Storage and transportation environment temperature: - 40 °C ~ + 55 °C,

relative humidity: 10% ~ 90%. Only when the machine is repaired, maintained or improved by the engineers approved by Zhongke Meiling bio-medical treatment can we guarantee its normal operation and meet the corresponding safety standards. The warranty period of the machine, if due to improper use of users caused by failure or damage, the company will not assume the warranty obligations.

9. Specification

Name	Medical Freezer/Ultra low temperature freezer
Model	GL-F-10M
Outside cabinet	PCM color plate
Outside door	Epoxy polyester powder coated steel plate
Condenser	Built-in galvanized tube
Evaporator	Wire tube
Insulation	Rigid polyurethane foam filling
Compressor	Fully enclosed
Thermostat	Microcomputer control system
Temperature sensor	NTC
Alarm system	High/low temperature alarm, door ajar alarm, sensor error alarm.

10. Performance

10.1 Main Technical Parameter

Model	Ambient temperature (°C)	Refrigerant	Rated voltage (V)	Rated frequency (Hz)	Storage temperature (°C)	Net capacity (L)	Rated current (A)	Net weight (Kg)	Exterior dimension (W*D*H) (mm)
GL-F-10M	16 ~ 32°C	R600a/97g	220	50	-10 ~ -25	270	1.08	87	700×640×1792

10.2 Packing List

Name	Operation manual	Keys	Defrost shovel
GL-F-10M	1	1×2	1

10.3 Electrical Diagram

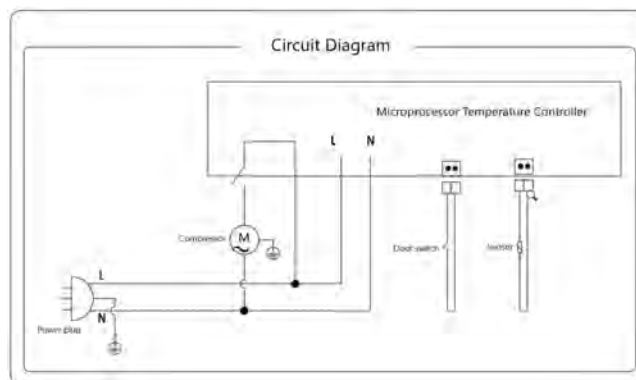

GL-F-10M

If the product design is improved, the technical data and electrical schematic diagram shall be subject to the nameplate of the product.